

Lemair

Since 1956

User Manual
LBC6178 Beverage Centre
LWC646 Wine Storage
Built Under



Congratulations on purchasing your new Lemair product.

It is important that you read through the following use and care manual thoroughly to familiarize yourself with the installation and operation requirements of your appliance to ensure optimum performance.

Our Customer Care centre is there to ensure you get the most out of your appliance.
For any after sales service please contact our Customer Care team

on

1800 444 357

or email

service@hapl.com.au

We also carry a complete range of spare parts for all Lemair products.
For all your spare parts enquiries please contact our team at **Pronto Parts** on:

1300 306 973

Lemair is a division of Home Appliances PTY LTD
20 Carlotta Street Artarmon 2064
Sales
1800 805 300
Service
1800 444 357
Website
www.lemairappliances.com.au

CONTENTS



IMPORTANT SAFETY INFORMATION	1
DESCRIPTION OF APPLIANCE AND INSTALLATION	3
145L (LWC646 and LBC6178).....	3
ACCESSORY INSTALLATION BEFORE OPERATING	4
UNPACKING AND CLEANING THE WINE COOLER	4
LOCK & UNLOCK THE DOOR (FOR OPTION).....	4
OPERATING THE WINE COOLER.....	5
WORKING CLIMATE	5
WINE STORAGE	5
CONTROL PANEL	6
POWER ON/OFF CONTROL.....	7
UNLOCKING THE CONTROL PANEL.....	7
INTERIOR LIGHTING ON/OFF CONTROL	7
TEMPERATURE DISPLAY WINDOW	7
TEMPERATURE SETTING	8
SELECTING FAHRENHEIT(°F) & CELSIUS (°C) DISPLAY.....	9
CARE AND MAINTENANCE	9
CLEANING THE WINE COOLER.....	9
POWER FAILURE.....	9
MOVING THE WINE COOLER	9
ENERGY SAVING TIPS	9
TROUBLESHOOTING	10
REVERSE THE DOOR SWING	11
145L	11

- Please remove all packaging, stickers and films from the products surface and clean the product's surfaces with a damp cloth and mild detergent before using for the first time.
- Let the appliance stand upright for approximately **24** hours before connecting it to the power source, which helps to reduce the possibility of a cooling-system malfunction from handling during transportation.

IMPORTANT SAFETY INFORMATION

Before using the appliance, please properly position and install it as described in this manual. To avoid the risk of fire, electrical shock, or injury when using the appliance, follow these basic precautions:

- This appliance is for domestic purposes only and is intended to be used exclusively for the storage of sealed bottled wines and beverages.
- The appliance must be positioned so that the plug is accessible.
- Make sure the voltage/current marked on the rating label corresponds with your supply voltage. Plug into a grounded 3-pin outlet, do not remove grounding pin, do not use an adapter, and do not use an extension cord.
- **Do not** connect or disconnect the electric plug with wet hands.
- To disconnect the appliance, grip the plug and pull it from the wall outlet. Never pull out by the cord.
- It is recommended that a separate circuit, serving only your appliance be provided.
- Unplug the appliance or disconnect power before cleaning, maintenance or servicing. Failure to do so can result in electrical shock or death.
- If the supply cord is damaged, it must be replaced by the manufacturer or its service agent or a similarly qualified person in order to avoid a hazard.
- The fuse (or circuit breaker) size should be **10 amps** or higher.
- This appliance can be used by children aged from 8 years and persons with reduced physical, sensory or mental capabilities or lack of experience and knowledge if they have been given supervision or instruction concerning use of the appliance in a safe way and understand the hazards involved. Children shall not play with the appliance. Cleaning and user maintenance shall not be made by children without supervision.
- This appliance is not intended for use by persons (including children) with reduced physical, sensory or mental capabilities, or lack of experience and knowledge, unless they have been given supervision or instruction concerning use of the appliance by a person responsible for their safety.
- Children should be supervised to ensure that they do not play with the appliance.

- To ensure proper ventilation for the appliance, the front of the unit must be completely unobstructed. Locate the unit away from direct sunlight and sources of heat (stove, heater, radiator, etc.).
- **Do not** attempt to repair or replace any part of the appliance unless it is specifically recommended in this manual. All other servicing should be referred to a qualified technician.
- Ensure there are enough people to move and install the appliance to avoid any damage to the appliance or injury to the any person.
- It is important for the appliance to be levelled in order to work properly. You may adjust the appliance's feet to level it.
- Never clean the appliance parts with flammable fluids which may create a fire hazard or explosion. And do not store or use gasoline or other flammable vapours and liquids in the vicinity of the appliance.
- **Do not** use solvent-based cleaning agents or abrasives on the interior. These cleaners may damage or discolour the interior.
- **Do not** use this appliance for other than its intended purpose.
- **Do not** use electrical appliance inside the appliance.
- The use of attachments not recommended by the manufacturer may be hazardous.
- Please keep the products away from the fire or similar glowing substance before you dispose the appliance.
- GWP (Global Warming Potential): R600a=3
- When you dispose the appliance, take off the door and leave the shelves in place so that children may not easily climb inside. And make sure the coolant circuit, particularly the heat exchanger at the back/bottom of the unit is not be damaged.
-  The recycle symbol on the product or its packaging indicates that this product is not to be handled as normal household waste and it is to be taken  to a recycling collection point for electrical and electronic goods.

DESCRIPTION OF APPLIANCE AND INSTALLATION

The following pictures only show description of appliance. The dimension and shelf quantity may differ among the models of the same series.

■ 145L – Model LWC646 Wine Cooler and Model LBC6178 Beverage Centre

Single Zone

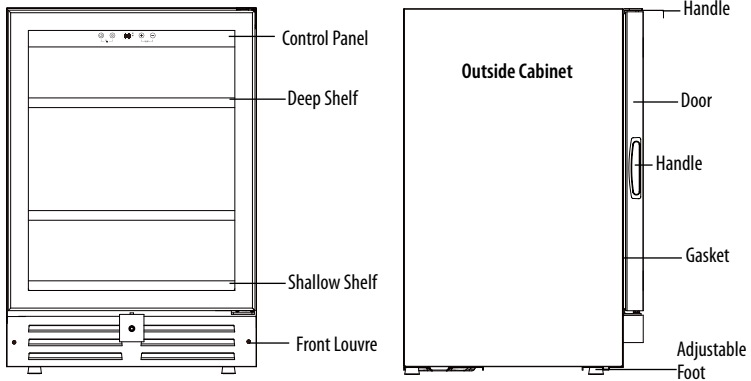

Dual Zone

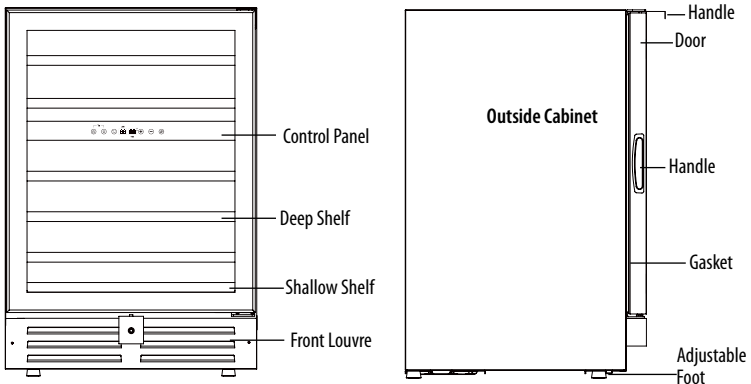

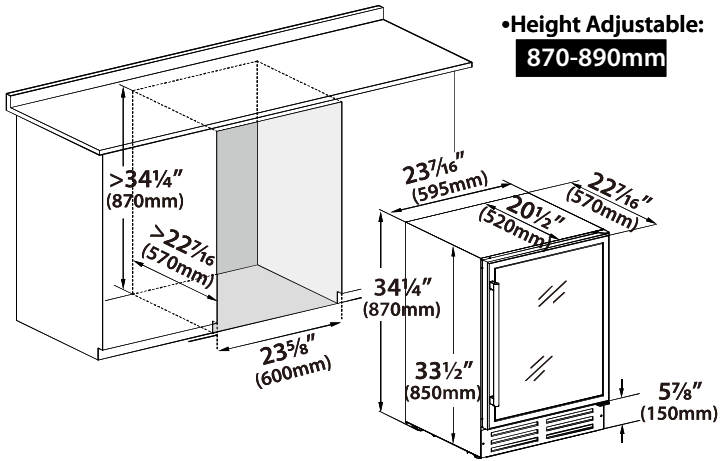

ACCESSORY INSTALLATION BEFORE OPERATING

■ UNPACKING AND CLEANING THE WINE COOLER

- Remove the exterior and interior packing materials.
- Let the appliance stand upright for approximately **24 hours** before connecting it to the power source, which helps to reduce the possibility of a cooling-system malfunction from handling during transportation.
- Use a soft cloth to clean the interior surface with lukewarm water.
- Install the door handle provided with the appliance by following these steps:

1st Step Before install the small handle, find 2 screws and the handle which are packed as accessories in the instruction manual bag.

2nd Step Tighten the 2 screws to fix the small handle on left top of the door frame.

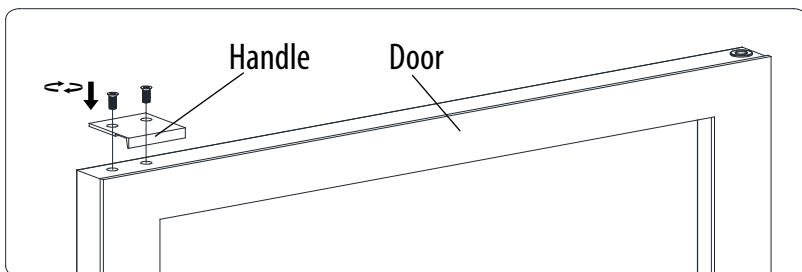

■ LOCK & UNLOCK THE DOOR (FOR OPTION)

- Lock is an optional function. If your Wine Cooler has such function, a key should be attached inside the packing of this Manual.

- Insert the key into the lock and turn it counter-clockwise to unlock the door. To lock it, please turn clockwise. Please save the key well.

OPERATING THE WINE COOLER

■ WORKING CLIMATE

- The appliance is designed for operating from ST to T climate (see below climate class chart). It is recommended to maintain the ambient around 22-25°C which helps the appliance working with low power consumption.

Climate Class	Ambient Temperature
SN	10 - 32 °C (50°F-90°F)
N	16 - 32 °C (61°F-90°F)
ST	18 - 38 °C (64°F-100°F)
T	18 - 43 °C (64°F-109°F)

- If the ambient temperature is above or below the designed climate range, the performance of the unit may be affected. For example, the appliance operating in extreme cold or hot conditions may cause interior temperatures to fluctuate, and the temperature set 5-22°C may not be reached sometimes.

■ WINE STORAGE

- The standard shelves are designed perfectly for Bordeaux bottle storage. The maximum loaded bottles may vary subject to the different size or dimension wine bottles you store.
- The shelves can be pulled out by 1/3 approximately for easy access to the wine storage. There are two designs for the pull-out shelves:
 1. The shelves are without telescopic rails, but with a plastic **Stopper** on each sides of the shelf track to prevent bottles from falling.
 2. The shelves are with **Telescopic Rails** which has stoppers by themselves.

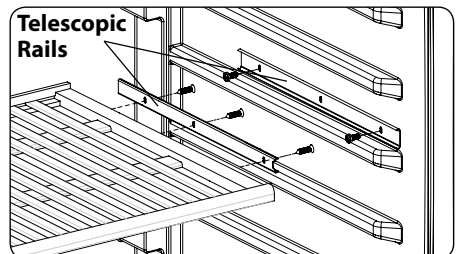
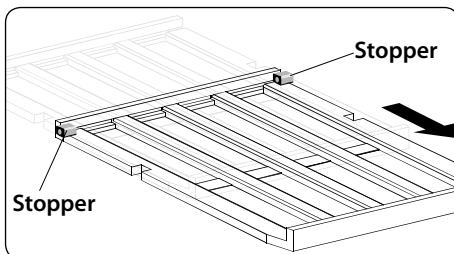

- To prevent damaging the door gasket, make sure to have the door opened fully all the way before pulling the shelves out.
- Please store wine in sealed bottles.
- Do not cover the shelves with aluminium foil or any other shelf material which may prevent air circulation.
- Should the wine cooler be left empty for long periods it is suggested that the appliance is unplugged, and after careful cleaning, leave the door ajar to allow air to circulate inside the cabinet in order to avoid possible condensation, mould or odours forming.
- Recommended temperatures for chilling/storing your wines.

Wine Type	Recommender Temp.
Red Wines	15 - 18°C (59°F-64°F)
Dry/White Wines	9 - 14°C (48°F-57°F)
Rose Wines	10 - 11°C (50°F-52°F)
Sparkling Wines	5 - 8°C (41°F-46°F)

■ CONTROL PANEL

For Single Zone

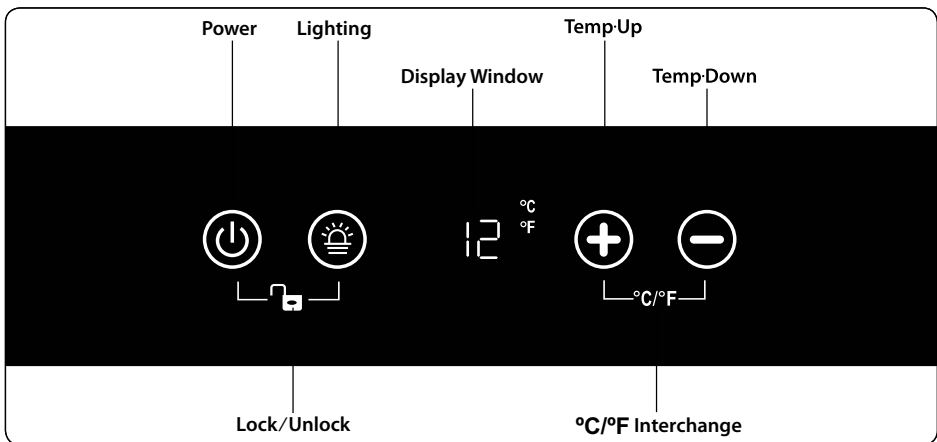

For Dual Zone

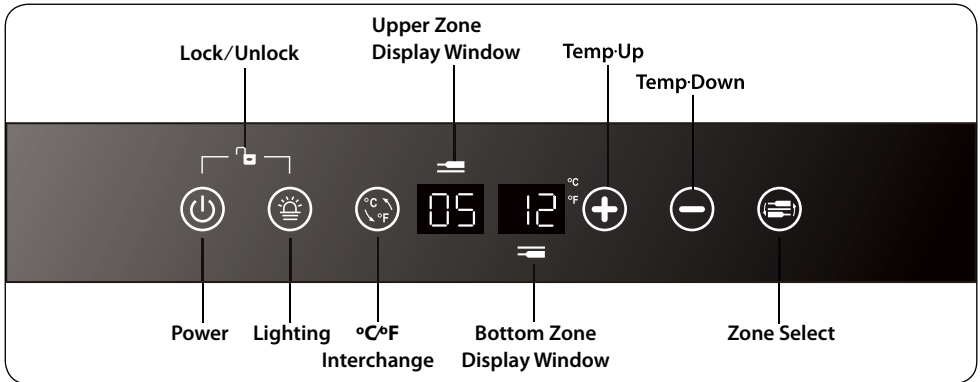

■ POWER ON/OFF CONTROL

- When the appliance is plugged in to a power outlet, it powers on automatically.
- Touch the power symbol (⏻) and hold for **10 seconds** to turn off (or turn on) the appliance.
- No matter it is under a locked or unlocked situation, you can turn off the appliance by touching the power symbol (⏻) and holding for **10 seconds**.



Warning: To avoid damaging the compressor, please do not turn on the appliance again within **5 minutes** after you turn it off.

■ UNLOCKING THE CONTROL PANEL

- To unlock the control panel, touch the power symbol and lighting symbol (⏻) with 2 fingers at the same time and hold for **3 seconds**. When unlocked a buzz sound will be heard.
- The control panel will be automatically locked with a buzz sound heard after **10 seconds** without being touched.
- Under the locked situation, the control panel will not react to any touching order for Lighting On/Off and Temperature Setting.

■ INTERIOR LIGHTING ON/OFF CONTROL

- Under the unlocked situation, touch the lighting symbol (💡) to turn on (or turn off) the interior cool LED lighting.
- The lighting will stay on until it is manually turned off.

■ TEMPERATURE DISPLAY WINDOW

- The temperature is displayed in digitally which is the best way for it to be read. The digital display is shown as the set temperature when setting the temperature, and







- it will change to display the real temperature of the inside cabinet after **10 seconds** without being touched.
- When the temperature probe is out of order, the display window will show with “HH” or “LL” instead of a digital figure while continuous buzz sound will be heard. In case of this happens, this appliance is considerably designed to keep periodical running of compressor and fans which helps to keep the coldness of the inside cabinet to protect your stored wines.









Warning: To avoid destroying your stored wines, it is strongly recommended to have the appliance repaired immediately, as the spare periodical running can not ensure the appliance to achieve the temperature you have set.

■ TEMPERATURE SETTING

For Single Zone

- The temperature setting range is 5-22°C (41-72°F). Beverage Centre model BBC6178 is 2-20°C (36-68°F)
- Directly touch the  or  symbol to set the wine cooler temperature as you want.
- The first touch on  or  symbol will recall the previous set temperature displayed.
- Touch the symbol  to increase the set temperature by 1°C (or by 1°F). On the contrary, touch the symbol  to decrease the set temperature by 1°C (or by 1°F).
- The digital will change to display the real temperature of the inside cabinet after **10 seconds** without being touched.

For Dual Zone



- The temperature setting ranges are 5-12°C (41-54 °F) for the upper zone and 12-22°C (54-72°F) for the bottom zone.
- You need to select the set zone by touching the symbol  before touching the symbol  or  to set the desired temperature. The zone temperature will flash when it is ready to be set.
- The first touch on symbol  or  will recall the previous set temperature displayed in the digital window.
- Touch the symbol  to increase the set temperature by 1°C (or by 1°F). On the contrary, touch the symbol  to decrease the set temperature by 1°C (or by 1°F).
- The digital will change to display the real temperature of the inside cabinet after **10 seconds** without being touched.

Note:

For the first time to use the appliance or to restart the appliance after having been shut off for a long time, you may find a few degrees variance between the set temperature and the displayed temperature. It will go back to normal after a few hours running

■ SELECTING FAHRENHEIT(°F) & CELSIUS (°C) DISPLAY

For Single Zone

- Touch the symbols   with 2 fingers at the same time and hold for 5 seconds, will interchange the Fahrenheit and Celsius display.

For Dual Zone

- Directly touching the symbol , will interchange the Fahrenheit and Celsius display for both zones at the same time.

CARE AND MAINTENANCE

■ CLEANING THE WINE COOLER

- Turn off the power, unplug the appliance, and remove all items including shelves.
- Wipe the inside surfaces with a sponge and baking soda solution. The solution should be about 2 tablespoons of baking soda to approximately 1 litre of warm water.
- Wash the shelves with a mild detergent solution. Allow wooden shelves to dry before placing back into the wine cooler.
- Wring excess water out of the sponge or cloth when cleaning area of the controls, or any electrical parts.
- Wipe the outside cabinet with warm water and mild liquid detergent. Wipe dry with a clean soft cloth.
- Do not use steel wool or steel brush on the stainless steel. These will scratch the stainless steel with steel particles and rusting may occur.

■ POWER FAILURE

Most power failures are corrected within a few hours and should not affect the temperature of your appliance if you minimise the number of door openings. If the power is going to be off for a longer period of time, you need to take the proper steps to protect your wines.

■ MOVING THE WINE COOLER

- Remove all items.
- Securely tape down all loose items (shelves) inside your appliance.
- Turn the adjustable leg up to the base to avoid damage.
- Tape the door shut.
- Be sure the appliance stays secure in the upright position during transportation. Also protect outside of appliance with a blanket, or similar item.

■ ENERGY SAVING TIPS

- The appliance should be located away from heat producing appliances, and away from direct sunlight.

- Ensure that the unit is adequately ventilated. Never cover air vents.
- Only open the door when necessary. Avoid leaving the door open for long periods or opening/closing the door frequently.

TROUBLESHOOTING

- If you feel the appliance is not working properly, follow these instructions to try to see if you can solve the problem simply by yourself before calling for service.

No.	PROBLEM	PROBLEM POSSIBLE CAUSE / MEASURE
1	The wine cooler does not operate	Not plugged in. The appliance is turned off. The circuit breaker tripped or a blown fuse.
2	The wine cooler is not cold enough	Check the temperature control setting. External environment may require a higher setting. The door is opened too frequently. The door is not closed completely. The door gasket does not seal properly.
3	Automatically turn-on and turn-off frequently	The room temperature is hotter than normal. A large amount of contents has been added to the wine cooler. The door is opened too frequently. The door is not closed completely. The temperature control is not set correctly. The door gasket does not seal properly.
4	The light does not work	Not plugged in. The circuit breaker tripped or a blown fuse. The light is turned off.
5	Too much vibration	Check to assure that the appliance is level. Check to assure no parts inside the cabinet or in the compressor chamber are loose.
6	The wine cooler seems to make too much noise	The rattling noise may come from the flow of the refrigerant, which is normal. As each cycle ends, you may hear gurgling sounds caused by the flow of refrigerant. Contraction and expansion of the inside walls may cause popping and crackling noises. The appliance is not level.
7	The door will not close properly.	The wine cooler is not level. The door was reversed and not properly installed. The gasket is dirty. The shelves are out of position.
8	The display window is shown with "HH" or "LL" instead of a digital figure, and/or with continuous buzz sound.	The temperature probe is out of order.

REVERSE THE DOOR SWING

Note:

- Door Reversal is **NOT available** for a unit with **Control Panel on Door**.
The following operation is only for a unit with Control Panel inside the cabinet.

■ 145L

Remarks:

- The instruction is based on a unit with Right Hinge installed already.
To reverse the door from right hinge to left hinge, you need to get ready 2 new spare parts: an **Upper Left Hinge**, and a **Bottom Left Hinge**.
 - All removed parts is suggested to be saved in case of door re-reversal.
1. Open the door, and loosen the 2 screws from Pivot Hinge of the Bottom Right Hinge.

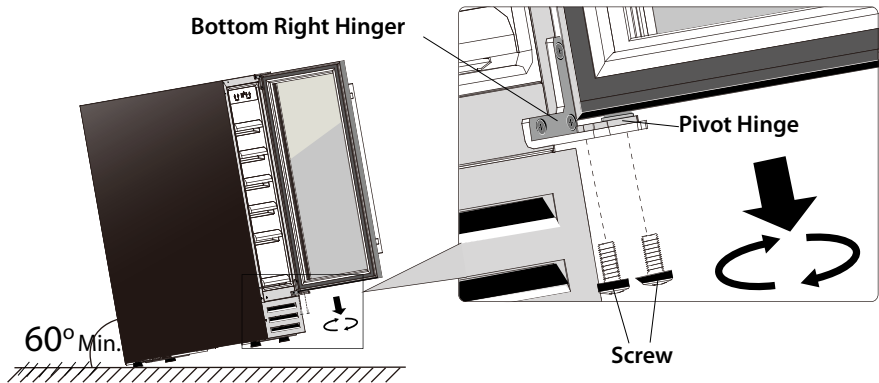

2. Carefully remove the door from the Upper Right Hinge and prevent it from scratching. Take out the Pivot Hinge from the door hinge hole.

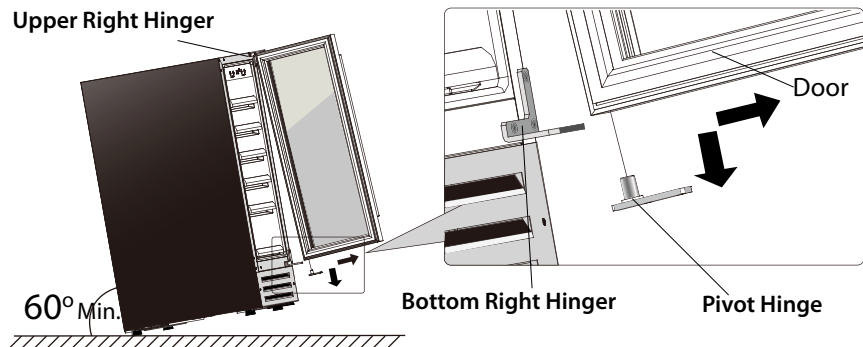

3. Unscrew the Upper Right Hinge and Bottom Right Hinge from the cabinet. Keep them well for door re-installation.

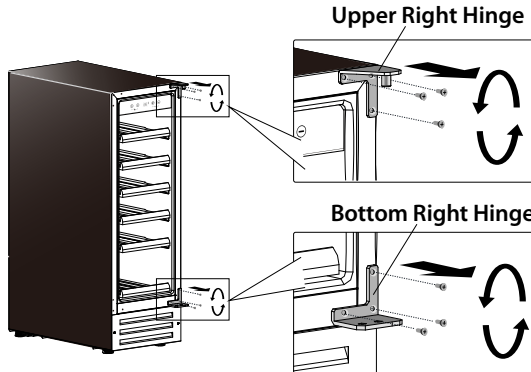

4. Pull out the 6 Plastic Caps at the front left corner of the cabinet. And move them all to the right side.

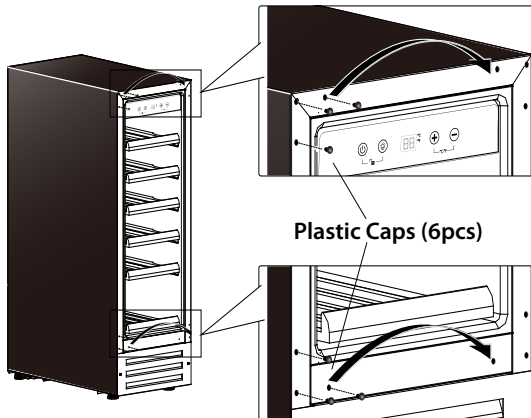

5. Install the Upper Left Hinge and Bottom Left Hinge to the left side of the cabinet. Make sure the screws are tightened.

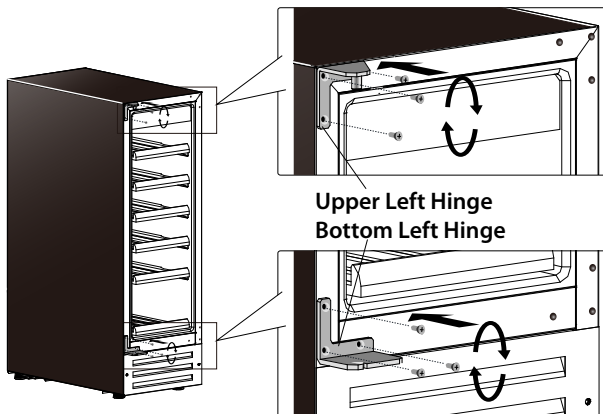

6. Loose the 2 screws with a cross screwdriver. Keep these screws and the handle well on one side for using later.

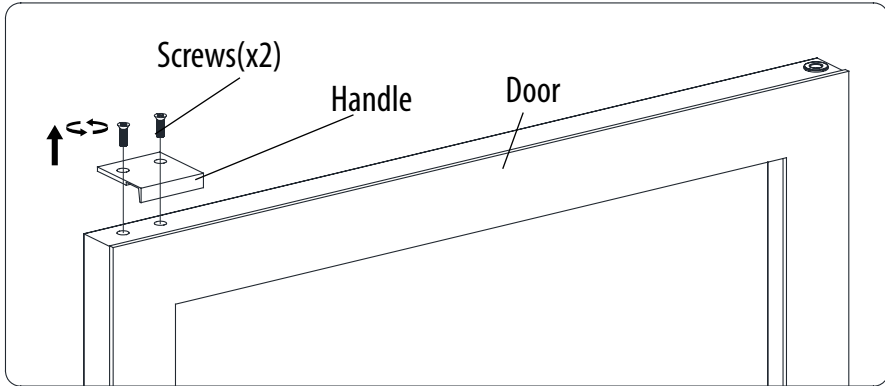

7. Turn the door by 180° (upside down) .

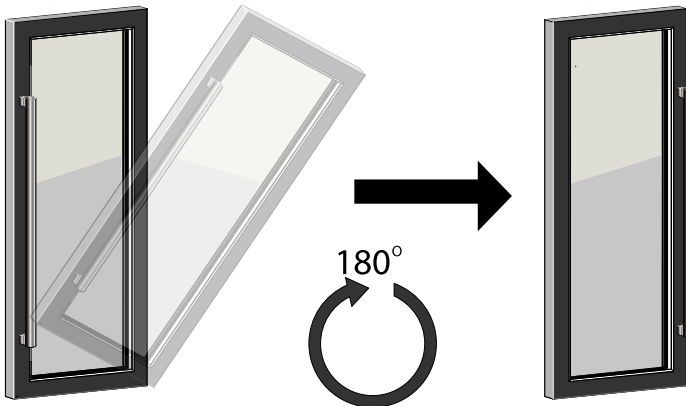

8 Insert the Pivot Hinge into the bottom hinge hole of the door.

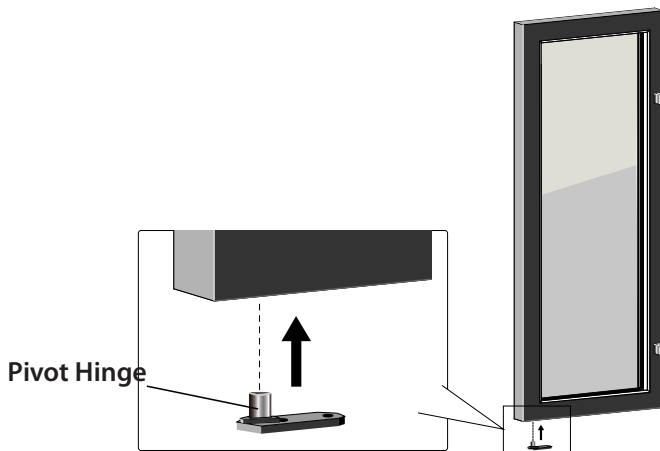

9. Install the door to the left hinge side by tightening the Pivot Hinge with the 2 screws.

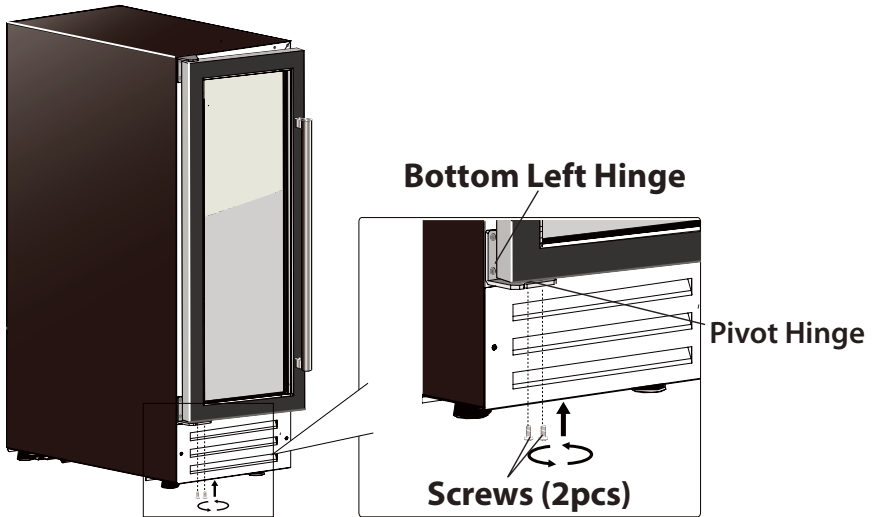

10. To reinstall the handle to the left top of door frame.

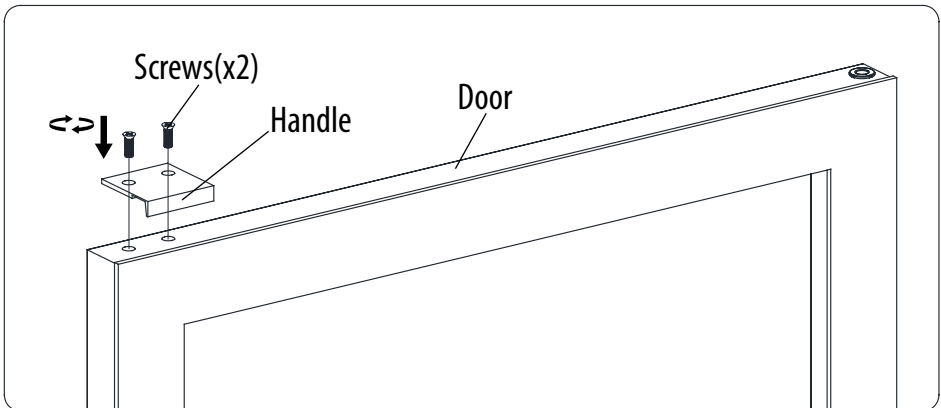

END

THIS PAGE HAS BEEN LEFT BLANK INTENTIONALLY

THIS PAGE HAS BEEN LEFT BLANK INTENTIONALLY

Lemair

lemairappliances.com.au